

This warranty is valid only in Canada.

**SONY**

Network Walkman  
Net MD Walkman  
Hi-MD Walkman

ATRAC CD Player  
ATRAC CD Walkman  
IC Recorder

## LIMITED WARRANTY

Sony of Canada ("Sony") warrants this Product (including any accessories) against defects in material or workmanship as follows:

- LABOUR:** For a period of 90 days from the date of purchase, if this Product is determined to be defective, Sony will repair or replace the Product, at its option, at no charge, or pay the labour charges to any Sony authorized service facility. After the Warranty Period, you must pay for all labour charges.
- PARTS:** In addition, Sony will supply, at no charge, new or rebuilt replacements in exchange for defective parts for a period of one (1) year. After 90 days from the date of purchase, labour for removal and installation is available from Sony authorized service facilities or a Sony Service Centre at your expense.

You can extend the warranty period for an additional nine months by registering your product ([www.sonymstyle.ca](http://www.sonymstyle.ca)). Once you register your product, the limited warranty period is twelve months from the original date of purchase from Sony or a Sony authorized dealer. The ninety (90) day warranty period is extend-able only to the original purchaser, for an additional period of nine (9) months, for a total of twelve (12) months from the date of purchase when the Product is registered electronically. After the applicable period you must pay for all parts and labour charges.

To obtain warranty service, you must take the Product, or deliver the Product freight prepaid, in either its original packaging or packaging affording an equal degree of protection, to any authorized Sony service facility.

This warranty does not cover customer instruction, installation, set up adjustments or signal reception problems.

This warranty does not cover cosmetic damage or damage due to acts of God, accident, misuse, abuse, negligence, commercial use, or modification of, or to any part of the Product, including the antenna. This warranty does not cover damage due to improper operation or maintenance, connection to improper voltage supply, or attempted repair by anyone other than a facility authorized by Sony to service the Product. This warranty does not cover Products sold AS IS or WITH ALL FAULTS, or consumables (such as fuses or batteries). This warranty is valid only in Canada.

Proof of purchase in the form of a bill of sale or receipted invoice which is evidence that the unit is within the Warranty period must be presented to obtain warranty service.

This warranty is invalid if the factory-applied serial number has been altered or removed from the Product.

**REPAIR OR REPLACEMENT AS PROVIDED UNDER THIS WARRANTY IS THE EXCLUSIVE REMEDY OF THE CONSUMER. SONY SHALL NOT BE LIABLE FOR ANY INCIDENTAL OR CONSEQUENTIAL DAMAGES FOR THE BREACH OF ANY EXPRESS OR IMPLIED WARRANTY ON THIS PRODUCT, EXCEPT TO THE EXTENT PROHIBITED BY APPLICABLE LAW. ANY IMPLIED WARRANTY OF MERCHANTABILITY OR FITNESS FOR A PARTICULAR PURPOSE ON THIS PRODUCT IS LIMITED IN DURATION TO THE DURATION OF THIS WARRANTY.**

Some provinces do not allow the exclusion or limitation of incidental or consequential damages, or allow limitations on how long an implied warranty lasts, so the above limitations or exclusions may not apply to you. This warranty gives you specific legal rights, and you may have other rights which vary from province to province.

For your convenience, Sony of Canada Ltd. has established telephone numbers for frequently asked questions:

To locate the service or dealer nearest you, or for service assistance or resolution of a service problem, or for product information or operation, call:

**Sony Customer Information Center**

1-877-770-7669

or write to:

Sony of Canada Ltd.  
115 Gordon Baker Road, Toronto, Ontario M2H 3R6 CANADA

or visit:

[www.sonymstyle.ca/registration](http://www.sonymstyle.ca/registration)  
Portable Audio

This information is used to process your warranty registration and for after-sales support purposes. It may also be used by Sony of Canada Ltd. and affiliated Sony companies for customer relationship development and analysis, and to provide you with information and promotional offers on other products and services that may be of interest to you. For a copy of our Privacy Code, please visit our website at [www.sonymstyle.ca/privacy](http://www.sonymstyle.ca/privacy) or call 1-877-899-7669.

D 324511302

**SONY**

Atrac CD Walkman

Portable  
CD Player 



Atrac3plus



Printed on 100 % recycled paper using  
VOC (Volatile Organic Compound)-free  
vegetable oil based ink.

<http://www.sony.net/>

Sony Corporation Printed in Malaysia



\* 2 5 4 1 6 3 7 1 2 \* (1)

© 2005 Sony Corporation

D-NE720/NE720LS

Operating Instructions



## WARNING

**To prevent fire or shock hazard, do not expose the unit to rain or moisture.**

Do not install the appliance in a confined space, such as a bookcase or built-in cabinet.

To prevent fire, do not cover the ventilation of the apparatus with newspapers, tablecloths, curtains, etc. And don't place lighted candles on the apparatus.

To prevent fire or shock hazard, do not place objects filled with liquids, such as vases, on the apparatus.

### CAUTION

The use of optical instruments with this product will increase eye hazard.

Certain countries may regulate disposal of the battery used to power this product. Please consult with your local authority.

### CAUTION

- INVISIBLE LASER RADIATION WHEN OPEN
- DO NOT STARE INTO BEAM OR VIEW DIRECTLY WITH OPTICAL INSTRUMENTS
- CLASS 1M INVISIBLE LASER RADIATION WHEN OPEN
- DO NOT VIEW DIRECTLY WITH OPTICAL INSTRUMENTS

The validity of the CE marking is restricted to only those countries where it is legally enforced, mainly in the countries EEA (European Economic Area).

ATRAC3plus is a trademark of Sony Corporation.

“WALKMAN” is a registered trademark of Sony Corporation to represent Headphone Stereo products.  WALKMAN is a trademark of Sony Corporation.

For the customers in the Canada

### RECYCLING NICKEL METAL HYDRIDE BATTERIES

Nickel Metal Hydride batteries are recyclable.

You can help preserve our environment by returning your used rechargeable batteries to the collection and recycling location nearest you.



For more information regarding recycling of rechargeable batteries, call toll free 1-800-822-8837, or visit <http://www.rbrbc.org/>.

**Caution:** Do not handle damaged or leaking Nickel Metal Hydride batteries.



**Disposal of Old Electrical & Electronic Equipment (Applicable in the European Union and other European countries with separate collection systems)**

This symbol on the product or on its packaging indicates that this product shall not be treated as household waste.

Instead it shall be handed over to the applicable collection point for the recycling of electrical and electronic equipment.

By ensuring this product is disposed of correctly, you will help prevent potential negative consequences for the environment and human health, which could otherwise be caused by inappropriate waste handling of this product. The recycling of materials will help to conserve natural resources. For more detailed information about recycling of this product, please contact your local Civic Office, your household waste disposal service or the shop where you purchased the product.

Applicable accessories:

Earphones, Remote control (Remote)

# Table of Contents

<b>Create Your Own ATRAC CDs</b> .....	4
Which discs can you play on this CD player? .....	5
<b>Precautions</b> .....	7
On safety .....	7
On the CD player .....	7
On handling CDs .....	7
On headphones/earphones .....	7

## Getting Started

<b>Checking the Supplied Accessories</b> ....	8
<b>Guide to Parts and Controls</b> .....	9
<b>Preparing a Power Source (Rechargeable Battery)</b> .....	11
When using a dry battery .....	12
Checking the remaining power of the battery .....	13
When using the AC power adaptor.....	14

## Playback

<b>Playing a CD</b> .....	15
Basic playback operations (Play, stop, search) .....	16
Locking the controls (HOLD) .....	17
<b>Searching for Your Favorite Track/File</b> .....	17
Searching by viewing a list of groups/files (List View) .....	17
Checking CD information on the display ..	18
<b>Changing Playback Options (PLAY MODE)</b> .....	19
Playback options (PLAY MODE) .....	20
Playing groups.....	21
Playing your favorite tracks (Bookmark play).....	21
Playing your favorite play lists (m3u play list play).....	21

Playing tracks in your favorite order (PGM play).....	22
Playing tracks repeatedly (Repeat play) ..	22
<b>Changing Sound Quality</b> .....	23
Selecting the sound quality .....	23
Customizing sound quality .....	23
SOUND items .....	25
<b>Changing Optional Settings</b> .....	26
Setting various functions .....	26
OPTION items .....	27
<b>Connecting Other Devices</b> .....	30
<b>Additional Information</b>	
<b>Troubleshooting</b> .....	31
<b>Maintenance</b> .....	34
<b>Specifications</b> .....	34
<b>Optional Accessories</b> .....	35
<b>Index</b> .....	36

This manual describes how to use the CD player. For the supplied software SonicStage, please see "Installation/Operating Guide."

### Notice for users

#### On the supplied software

Depending on the type of the text and characters, the text shown on SonicStage may not be displayed properly on the device. This is due to:

- The limitations of the connected player.
- The player is not functioning normally.

Instructions in this manual mainly describe the controls on the remote.

Depending on the region in which you use the player, indications displayed on your remote may be slightly different from those shown on the Operating Instructions.

## Create Your Own ATRAC CDs

In addition to the usual audio CDs, you can play an original CD, called “ATRAC CD,” that you create with the supplied software, SonicStage. Using SonicStage, about 30 audio CDs\* can be recorded on one CD-R or CD-RW.

The following is a quick overview of how you listen to music on your ATRAC CD.

### Install SonicStage on your computer.

SonicStage is software that takes music downloaded from audio CDs on your computer and creates original CDs. It can be installed from the supplied CD-ROM.



### Create an ATRAC CD.

After selecting your favorite songs from music stored on your computer, record them on a CD-R/CD-RW using SonicStage.

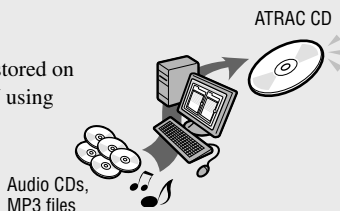

### Listen to them with this CD player.

You can take lots of songs wherever you go on your original CD.



Please see the supplied “Installation/Operating Guide” for how to install SonicStage and how to create ATRAC CDs.

\* When the total playing time of one CD (album) is estimated at 60 minutes and you are recording on a 700MB CD-R/CD-RW at 48kbps in ATRAC3plus format.

## Which discs can you play on this CD player?



### Audio CDs:

#### CD-DA format CDs

CD-DA (Compact Disc Digital Audio) is a recording standard used for Audio CDs.



### ATRAC CDs:

#### CD-R/CD-RW on which audio data compressed in the ATRAC3plus format has been recorded by using SonicStage\*

ATRAC3plus (Adaptive Transform Acoustic Coding3plus) is audio compression technology that satisfies the demand for high sound quality and high compression rates. ATRAC3plus can compress audio files to about 1/20 of their original size at 64 kbps.

Bit rates and sampling frequencies this CD player can play are:

	Bit rates	Sampling frequencies
ATRAC3	66/105/132 kbps	44.1 kHz
ATRAC3plus	48/64/256 kbps	44.1 kHz

Up to 62 characters can be displayed on this CD player.



### MP3 CDs:

#### CD-R/CD-RW on which audio data compressed in the MP3 format has been recorded by using a software other than SonicStage\*

Bit rates and sampling frequencies this CD player can play are shown below. Variable Bit Rate (VBR) files can also be played.

	Bit rates	Sampling frequencies
MPEG-1 Layer3	32 - 320 kbps	32/44.1/48 kHz
MPEG-2 Layer3	8 - 160 kbps	16/22.05/23 kHz
MPEG-2.5 Layer3	8 - 160 kbps	8/11.025/12 kHz

This CD player conforms to Version 1.0/1.1/2.2/3/2.4 of the ID3 tag format. ID3 tag is a format for adding certain information (track name, album name, artist name, etc.) to MP3 files. Up to 64 characters of ID3 tag information can be displayed on this CD player.



### CD-Extra and Mix-Mode CD:

#### CD-R/CD-RW on which CD-DA format data and CD-ROM format data are recorded together.\*

If you cannot play your CD, change the "CD-EXTRA" setting in the OPTION menu (Ⓞ page 29). Then you may play your CD.

An ATRAC CD on which audio data compressed in the MP3 format has been recorded using software other than SonicStage can also be played.

With SonicStage, you cannot create a CD on which mixed format audio data is recorded.

\* Only ISO 9660 Level 1/2 and Joliet extension format discs can be played.

## Music discs encoded with copyright protection technologies

This product is designed to play back discs that conform to the Compact Disc (CD) standard. Recently, various music discs encoded with copyright protection technologies are marketed by some record companies. Please be aware that among those discs, there are some that do not conform to the CD standard and may not be playable by this product.

## Difference in File structures of ATRAC CDs and MP3 CDs

ATRAC CDs and MP3 CDs consist of “files” and “groups.” A “file” is equivalent to a “track” of an audio CD. A “group” is a bundle of files and is equivalent to an “album.”

For MP3 CDs, this CD player recognizes an MP3 folder as a “group” so that ATRAC CDs and MP3 CDs can be operated in the same way.

### The usable number of groups and files

- maximum number of groups: 256
- maximum number of files: 999

### Playing order of ATRAC CDs and MP3 CDs

For ATRAC CDs, files are played in the order selected in SonicStage.

For MP3 CDs, the playing order may differ depending on the method used to record MP3 files on the disc. A “play list” which contains an MP3 file playing order can also be played. In the following example, files are played in order of ① to ⑦.

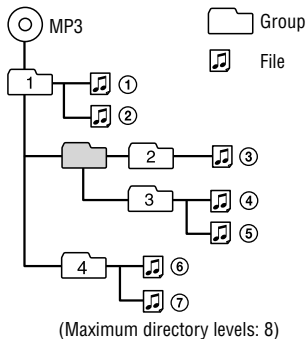

### Notes

- If ATRAC3plus files and MP3 files are recorded on the same CD, this CD player plays the ATRAC3plus files first.
- The playback capability of this CD player may vary depending on the quality of the disc and the condition of the recording device.
- Acceptable characters are A to Z, a to z, 0 to 9, and \_ (underscore).
- On a disc that has ATRAC3plus/MP3 files, do not save files in other formats and do not make unnecessary folders.

### About ATRAC CDs

- CD-Rs/CD-RWs recorded in the ATRAC3plus format cannot be played on your computer.

### About MP3 CDs

- Be sure to add the file extension “mp3” to the file name. However, if you add the extension “mp3” to a file other than an MP3 file, the player will not be able to recognize the file properly.
- To compress a source in an MP3 file, we recommend setting the compression parameters to “44.1 kHz,” “128 kbps,” and “Constant Bit Rate.”
- To record up to the maximum capacity, set the writing software to “halting of writing.”
- To record up to the maximum capacity at one time on media that has nothing recorded on it, set the writing software to “Disc at Once.”

---

## Precautions

### On safety

- Should any solid objects or liquid fall into the CD player, unplug it and have it checked by qualified personnel before operating it any further.
- Do not put any foreign objects in the DC IN 3 V (external power input) jack.

### On the CD player

- Keep the lens on the CD player clean and do not touch it. If you do so, the lens may be damaged and the CD player will not operate properly.
- Do not put any heavy object on top of the CD player. The CD player and the CD may be damaged.
- Do not leave the CD player in a location near heat sources, or in a place subject to direct sunlight, excessive dust or sand, moisture, rain, mechanical shock, unlevelled surface, or in a car with its windows closed.
- If the CD player causes interference to the radio or television reception, turn off the CD player or move it away from the radio or television.
- Discs with non-standard shapes (e.g., heart, square, star) cannot be played on this CD player. Attempting to do so may damage the CD player. Do not use such discs.

### On handling CDs

- To keep the CD clean, handle it by its edge. Do not touch the surface.
- Do not stick paper or tape onto the CD.
- Do not expose the CD to direct sunlight or heat sources such as hot air ducts. Do not leave the CD in a car parked under direct sunlight.

## On headphones/earphones

### Road safety

Do not use headphones/earphones while driving, cycling, or operating any motorized vehicle. It may create a traffic hazard and is illegal in some areas. It can also be potentially dangerous to play your headsets at high volume while walking, especially at pedestrian crossings. You should exercise extreme caution or discontinue use in potentially hazardous situations.

### Preventing hearing damage

Avoid using headphones/earphones at high volume. Hearing experts advise against continuous, loud and extended play. If you experience a ringing in your ears, reduce volume or discontinue use.

### Consideration for others

Keep the volume at a moderate level. This will allow you to hear outside sounds and to be considerate to the people around you.

## Checking the Supplied Accessories

- AC power adaptor (AC-ES3010K2)
- Earphones

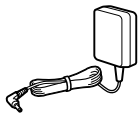

- Rechargeable battery
- Battery carrying case

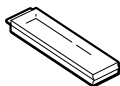

- External battery case

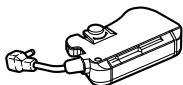

- Remote control (Remote)  
(For this CD player only)

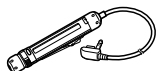

- CD-ROM (SonicStage)  
Do not play this CD-ROM on an audio CD player including this player.



- Operating instructions (This book)
- Installation/Operating Guide
- AC plug adaptor (Supplied with tourist model)

### Note

Use only the supplied remote. You cannot operate this player with any other remote.

### To connect your earphones/headphones to the remote

Connect the plug of your earphones/headphones to the remote securely.

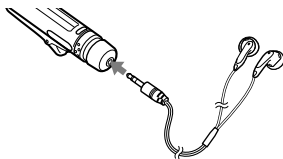

### To use the clip of the remote

You can change the direction of the clip. Turn the clip as shown below. You can also reverse the direction of the track name, etc. (☞ page 26, 28).

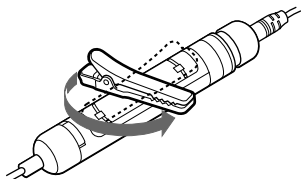



## Guide to Parts and Controls

### CD player (rear)

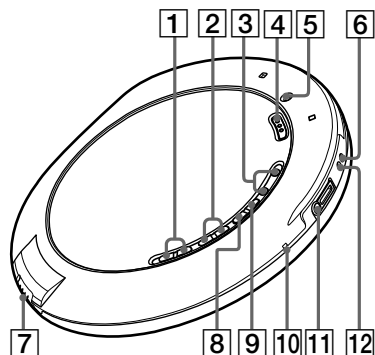

### Remote

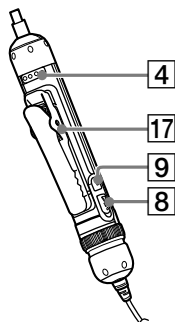
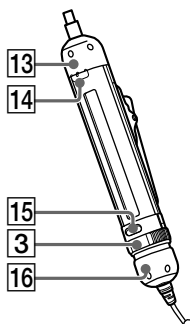

- 1 (group) +/- buttons (☞ page 16)
- 2 buttons (☞ page 16)
- 3 CD player:  
VOL (volume) +\*/- buttons (☞ page 15)  
Remote:  
VOL (volume) +/- control (☞ page 15, 17, 23)
- 4 HOLD switch (☞ page 17)
- 5 Screw hole for the external battery case
- 6 EXT BATT (external battery) jack (☞ page 12, 13)
- 7 OPEN switch (☞ page 11, 15)
- 8 (play/pause)\* button (☞ page 16, 17, 19, 21-24)
- 9 CD player:  
■/CHG (stop/charge) button (☞ page 11, 16)  
Remote:  
■ (stop) button (☞ page 16, 22, 24, 25, 27)
- 10 OPR (operation) lamp (☞ page 11, 12, 15, 17)
- 11 (headphones)/LINE OUT jack (☞ page 15, 30)
- 12 DC IN 3 V (external power input) jack (☞ page 14)
- 13 Function dial (☞ page 18, 19, 22, 23, 26)
- 14 Function button (☞ page 18, 19, 22, 23, 26)
- 15 SEARCH button (☞ page 17)
- 16 Operation dial (☞ page 16, 17, 21-23, 26)
- 17 Clip (☞ page 8)

\* This button has a tactile dot.

Continued

## Remote display

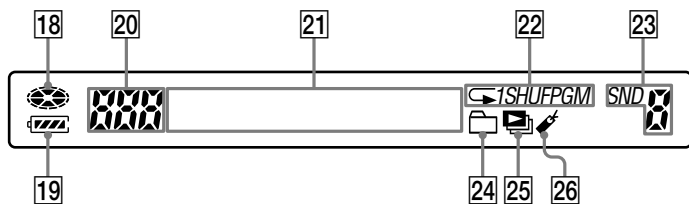

- 18 Disc indicator (☞ page 15)
- 19 Battery indicator (☞ page 11, 13)
- 20 Track number indicator/auto ranking play indicator (☞ page 18, 19)
- 21 Character information display (☞ page 18)
- 22 Play mode indicator (☞ page 20, 22)
- 23 Sound indicator (☞ page 23)
- 24 Group indicator (☞ page 20, 21)
- 25 Play list indicator (☞ page 20, 21)
- 26 Bookmark indicator (☞ page 20, 21)

## Preparing a Power Source (Rechargeable Battery)

Charge the rechargeable battery before using it for the first time or when it is depleted. To maintain the original battery capacity longer, charge the battery only when it is completely depleted ("Lo Batt" appears on the remote display).

- 1 Slide the OPEN switch to open the lid of your player.

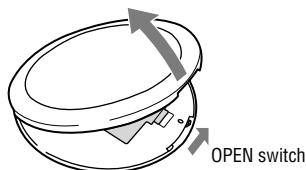

- 2 Open the battery compartment lid inside the player.

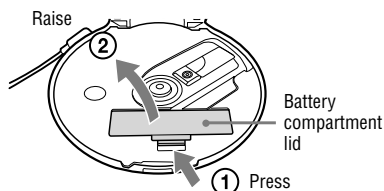

- 3 Insert the NH-14WM rechargeable battery (supplied) by matching the ⊕ to the diagram in the battery compartment and close the lid until it clicks into place.

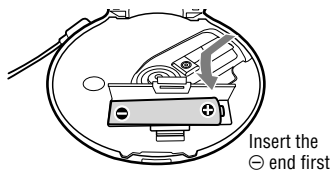

- 4 Connect the AC power adaptor to the DC IN 3 V jack of your player and an AC outlet.

Press ■/CHG to start charging. The player charges the battery. In the display of the remote control, "Charging" flashes and the indicator sections of  (battery) light up in succession. The OPR lamp lights up on the player.

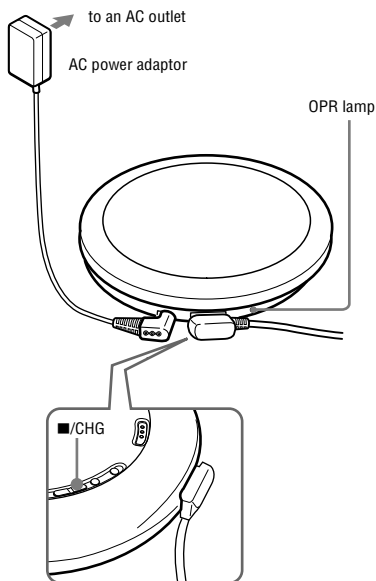

When the battery is completely charged, all indications on the display disappear and the OPR lamp goes off.

Continued 

## Notes

- Do not charge any rechargeable battery other than an NH-14WM (supplied) using this AC power adaptor.
- If you press ►|| during charging, charging stops and playback of CD starts.
- If you connect the AC power adaptor to player during playback, play stops.
- During charging, the player and the rechargeable battery become hot. This poses no danger.
- Connect the AC power adaptor securely. Make sure that the OPR lamp on the player lights up. Unsecure connection interrupts charging or play.
- Take out the rechargeable battery when the player is not to be used for a long time.

## To remove the rechargeable battery

Push the ⊖ end of the rechargeable battery.

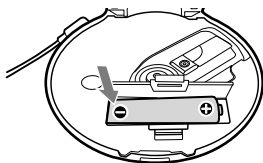

## Note on the useful life of the rechargeable battery and when to replace it

If the battery is new or has not been used for a long time, it may not charge completely. In that case, charge it until the OPR lamp goes off and then use the player until the battery is completely depleted (“Lo Batt” appears in the display). Repeat this procedure several times. When the battery life is still shorter by about half of a normal charge after trying this procedure, replace the battery with a new rechargeable battery.

## Note on carrying the rechargeable battery

Use the supplied battery carrying case to protect against unexpected heat. If the rechargeable battery comes into contact with the metallic objects, heat or fire may occur due to a short circuit.

## When using a dry battery

You can extend the power available by using a dry battery, together with a rechargeable battery by attaching the external battery case. Make sure to remove the AC power adaptor when attaching the external battery case. The battery in the player and that in the external battery case are discharged simultaneously.

When using the rechargeable battery and dry battery together to extend power, use a fully charged rechargeable battery and new dry battery.

- 1 Insert an LR6 (size AA) alkaline battery (not supplied) by matching the ⊕ to the diagram inside the battery case and close the battery case lid.

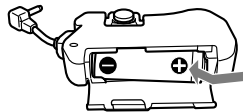

- 2 Attach the battery case to the player securely and fasten the screw in the direction of LOCK. Connect the battery case to EXT BATT jack.

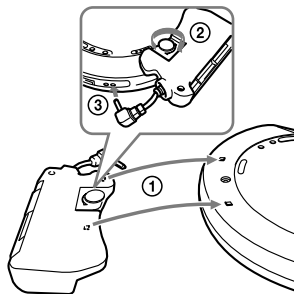

## To remove the external battery case

Unfasten the screw in the direction of RELEASE. Then, disconnect the battery case from EXT BATT jack.

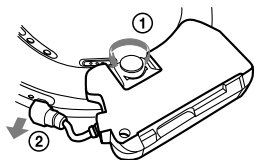

## Checking the remaining power of the battery

The remaining power of the battery is indicated in the remote display as shown below. As the black indicator section decreases, the remaining power is depleted further.



\* Beep sounds.

When the battery is depleted, charge the rechargeable battery or replace the dry battery with a new one.

### Notes

- The remote display shows the approximate battery power remaining. For example, one section does not always indicate one-fourth of the battery power.
- Depending on the operating conditions, the remote display may increase or decrease relative to the actual power remaining.

## Battery life <sup>1)</sup>

When using one NH-14WM rechargeable battery (charged for about 5 hours <sup>2)</sup>)

	G-PROTECTION	
	"1"	"2"
Audio CD	14	12
ATrac CD <sup>3)</sup>	30	29
MP3 CD <sup>4)</sup>	18	17

When using the external battery case (one alkaline battery <sup>5)</sup>)

	G-PROTECTION	
	"1"	"2"
Audio CD	22	20
ATrac CD <sup>3)</sup>	41	40
MP3 CD <sup>4)</sup>	26	25

When using one NH-14WM rechargeable battery and the external battery case (one alkaline battery <sup>5)</sup>)

	G-PROTECTION	
	"1"	"2"
Audio CD	37	33
ATrac CD <sup>3)</sup>	72	70
MP3 CD <sup>4)</sup>	45	43

1) Measured value using the JEITA standard (Japan Electronics and Information Technology Industries Association)

Playing time shown is approximate hours, when you use the player on a flat and stable surface and "POWERSAVE" is set to "2" (Ⓞ page 28). This value varies depending on how the player is used.

2) Charging time varies depending on how the rechargeable battery is used.

3) Recorded at 48kbps

4) Recorded at 128kbps

5) When using a Sony LR6 (SG) alkaline battery (produced in Japan)

Continued ➞

## Notes on rechargeable batteries and dry batteries

- Do not charge dry batteries.
- Do not throw the batteries into a fire.
- Do not carry batteries in a pocket, etc. with coins or other metallic objects. The battery can generate heat if its positive and negative terminals are accidentally allowed to come into contact with a metallic object.
- When the batteries are not to be used for a long time, remove them.
- If battery leakage occurs, wipe off any deposit left in the battery compartment, and install new batteries. If the deposit adheres to your skin, wash it off thoroughly.

## When using the AC power adaptor

You can use the player powered by the AC power adaptor without batteries.

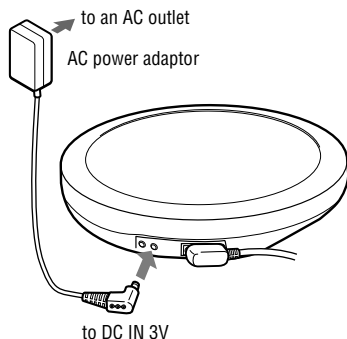

- 1** Connect the AC power adaptor to the DC IN 3V jack of your CD player and an AC outlet.

### Notes on the AC power adaptor

- Disconnect all power sources when the player is not to be used for a long time.
- Use only the AC power adaptor supplied. If your player is not supplied with the one, use an AC-E30HG AC power adaptor (not available in Australia). If you use any other AC power adaptor, malfunction may occur.

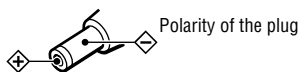

- Do not touch the AC power adaptor with wet hands.
- Connect the AC power adaptor to an easily accessible AC outlet. Should you notice an abnormality in the AC power adaptor, disconnect it from the AC outlet immediately.

## Playing a CD

### 1 Slide the OPEN switch to open the player lid.

Connect the headphones/earphones with the remote to the player beforehand.

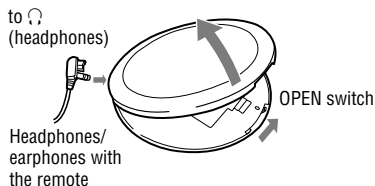

### 2 Place the CD on the tray and close the lid.

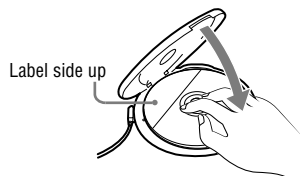

The OPR lamp lights up repetitively in red, green, and orange, in turn.

### 3 Press ►|| on the remote.

(disc) moves, and the player starts playback.

Color of the OPR lamp changes according to the format type of the music source (see page 5) being played. Red: CD-DA format, Green: ATRAC3plus format and Orange: MP3 format.



### 4 Adjust the volume by turning the VOL +/- control on the remote.

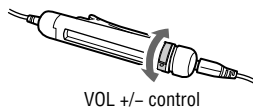

### On the CD player

After placing the CD on the tray in step 2, press ►|| and adjust the volume by pressing VOL +/-.

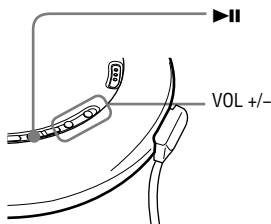

### To remove the CD

Remove the CD while pressing the pivot in the center of the tray.

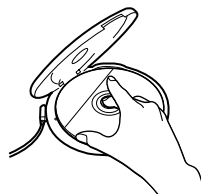

Continued ➞

## Basic playback operations (Play, stop, search)

### Remote

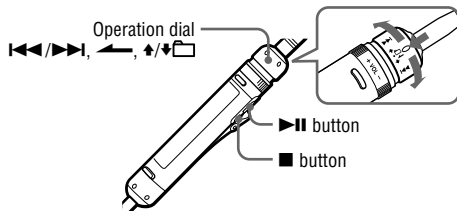

To	Operation on the remote (Operation on the player is in parentheses)	
<b>Play</b>	Play from the first track	From stop, press and hold ▶   until playback starts. (From stop, press and hold ▶   until playback starts.)
<b>Stop</b>	Pause/Resume play after pausing	Press ▶  . (Press ▶  .)
	Stop playback	Press ■ (stop). (Press ■/CHG.)
<b>Search</b>	Find the beginning of the current track <sup>1)</sup>	Turn the operation dial toward ◀◀ once. (Press ◀◀ once.)
	Find the beginning of previous tracks <sup>1)</sup>	Turn the operation dial toward ◀◀ repeatedly. (Press ◀◀ repeatedly.)
	Find the beginning of the next track <sup>1)</sup>	Turn the operation dial toward ▶▶ once. (Press ▶▶ once.)
	Find the beginning of succeeding tracks <sup>1)</sup>	Turn the operation dial toward ▶▶ repeatedly. (Press ▶▶ repeatedly.)
	Go backwards quickly <sup>1) 3)</sup>	Turn the operation dial toward ◀◀ and hold it. (Press and hold ◀◀.)
	Go forward quickly <sup>1) 3)</sup>	Turn the operation dial toward ▶▶ and hold it. (Press and hold ▶▶.)
	Jump to succeeding groups <sup>2)</sup>	Turn the operation dial toward ▶◻ repeatedly while you keep the dial pressed in the direction of ▶◻. (Press ◻ (group) + repeatedly.)
Jump to previous groups <sup>2)</sup>	Turn the operation dial toward ◻◻ repeatedly while you keep the dial pressed in the direction of ◻◻. (Press ◻ (group) – repeatedly.)	

1) You can operate during both play and pause.

2) You can operate during play of a CD other than audio CDs.

3) You cannot operate when using an MP3 file recorded on a CD-R/CD-RW in a packet write format.



## Locking the controls (HOLD)

You can prevent accidental button presses while carrying the player by locking the controls. The OPR lamp flashes if you press any button when the HOLD function on the player is activated.

### 1 Slide the HOLD switch on the remote or on the player (on the back) in the direction of the arrow.

You can use the HOLD function for the remote and the player separately. For example, even if the HOLD function on the player is activated, you can operate the player by using the remote unless you set HOLD on the remote to on, too.



### To unlock the controls

Slide the HOLD switch in the direction opposite to that of arrow.

#### Note

Even if the HOLD function is working, "HOLD" will not appear on the display of the remote.

## Searching for Your Favorite Track/File

### Searching by viewing a list of groups/files (List View)

You can search for a track/file by checking the format type of the music source and the names of groups and files.

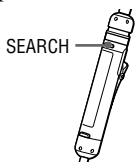

### 1 Press SEARCH on the remote.

### 2 Turn the VOL +/- control to select a group, and then press ►II.

If you select a group on an MP3 CD, etc. by searching through all the directories, turn the operation dial toward ◀◀◀ or ▶▶▶.

### 3 Turn the VOL +/- control to select a file, and then press ►II.

The file you have selected starts playing.

### To return to the previous screen

Turn the operation dial on the remote toward ◀◀◀, or turn the operation dial toward ▼☐ while you keep the dial pressed in the direction of ◀◀◀.

### To cancel searching

Press ■ on the remote.

Continued ➡

## Checking CD information on the display

You can check CD information on the remote display.

Depending on the region in which you purchased your CD player, the default language may not be "ENGLISH." Change the LANGUAGE setting, if necessary (Ⓜ page 27).

When you are playing an MP3 CD containing files with an ID3 tag, ID3 tag information is displayed. (When there is no ID3 tag information, file name or group name is displayed.) (Ⓜ page 5)

### Notes

- The characters A-Z, a-z, 0-9, and \_ can be displayed on this remote.
- Before playing a file, the player reads all file and group (or folder) information on the CD. "Reading" is displayed. Depending on the content of the CD, it may take some time to accomplish this reading.
- If the file does not belong to any group, "MP3 ROOT" appears on the remote display.

## To check information on the remote display

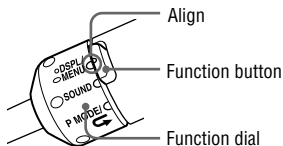

Turn the function dial on the remote to select DSPL/MENU, and press the function button repeatedly.

### Audio CD

Track number, elapsed playing time (Track name, artist name) <sup>1)</sup>

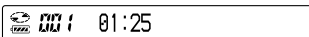

Total number of the files on the CD, time remaining on the CD (Album name) <sup>1)</sup>

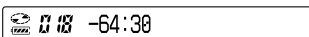

Animation screen



### ATRAC CD/MP3 CD

File number, file name, artist name, elapsed playing time

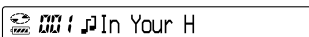

File number, album name, CODEC information <sup>2)</sup>, remaining time of the current file

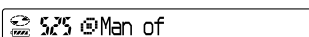

Animation screen

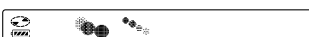



1)When you are playing an audio CD containing text information such as CD-TEXT, information in parentheses is displayed.

2)Bit rate and sampling frequencies are displayed. While an MP3 file made at VBR (variable bit rate) is being played, "VBR" appears on the display instead of a bit rate. In some cases, "VBR" appears halfway through playback, rather than from the beginning.

## Changing Playback Options (PLAY MODE)

You can use various playback options such as selecting songs you want to listen to, and playing songs in your favorite order.

For details about playback options, see  page 20.

You can also play songs repeatedly using the playback options you choose (repeat play,  page 22).

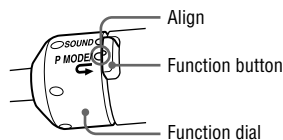

- 1 During play, turn the function dial on the remote to P MODE/⏮ and press the function button repeatedly to select a playback option.**

The playback option you selected lights up or flashes.

If the playback option flashes, press **▶||**.

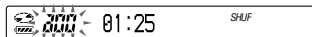





### To return to normal play

Turn the function dial on the remote to P MODE/⏮ and press the function button repeatedly until the playback option disappears.

Continued 

## Playback options (PLAY MODE)

Display on the remote	Explanation
No indication (Normal play)	All tracks on the CD are played in a track number order. For the ATRAC CD/MP3 CD, a playing order is different according to the setting of the "PLAYORDER" in the OPTION menu.
 (Group play)	All tracks in the selected group or all groups are played (ATRAC CD/MP3 CD only) (☞ page 21).
1 (Single play)	The current track is played once.
SHUF (Shuffle play)	All tracks on the CD are played once in random order.
 SHUF (Group shuffle play)	All tracks in the selected group are played once in random order (ATRAC CD/MP3 CD only) (☞ page 21).
 (Bookmark play)	Tracks to which Bookmarks have been added are played. The play of tracks with Bookmarks starts in track number order, not in the order you added the Bookmarks (☞ page 21).
 (m3u play list play)	Tracks in the selected m3u play list* are played (MP3 CD only) (☞ page 21)
a00 (Auto ranking play)	The tracks you have played most frequently from the CD are played from the 10th to the first.
a00 SHUF (Auto ranking shuffle play)	Up to 32 tracks, which the player has automatically memorized as the most frequently played ones, are played in random order.
PGM (PGM play)	Up to 64 tracks are played in your favorite order (☞ page 22).
INTRO (INTRO play)	About the first 10 seconds of all tracks which follow the current track are played once. If you turn the function dial to select P MODE/  , and press the function button during INTRO play, you can listen to the current track to the end.

\* An m3u play list is a file in which an MP3 file playing order has been encoded. To use the play list function, record MP3 files on a CD-R/CD-RW using encoding software that supports the m3u format.  
You can play the top 8 lists (listed by file name) on your screen on the remote.

## Playing groups

**1** In step 1 of “Changing Playback Options (PLAY MODE)” (Ⓞ page 19), select “□” or “□ SHUF.”

**2** Turn the VOL +/- control to select a group.

If you select a group on an MP3 CD, etc. by searching through all the directories, turn the operation dial toward ◀◀ or ▶▶.

If you select a group within the same directory, turn the VOL +/- control.

**3** Press ▶II for 2 seconds or more.

The player starts playback of all files in the group you have selected.

### Note

If the group has no tracks, “Invalid” appears on the display.

## Playing your favorite tracks (Bookmark play)

**1** During play of the track to which you want to add a Bookmark, press and hold ▶II on the remote until ⚡ flashes slowly.

**2** If you want to add a Bookmark to two or more tracks, repeat step 1.

You can add Bookmarks to up to 10 CDs for audio CDs (up to 99 tracks for each CD) and up to 5 CDs for ATRAC CDs/MP3 CDs (up to 999 tracks for each CD).

**3** In the step 1 of “Changing Playback Options (PLAY MODE)” (Ⓞ page 19), select ⚡ (BOOKMARK).

**4** Press ▶II.

## To remove Bookmarks

During play of a track with a Bookmark, press and hold ▶II on the remote until ⚡ disappears.

### Notes

- If you try to add Bookmarks to tracks on an 11th CD (on a 6th CD when playing ATRAC CDs/MP3 CDs), the Bookmarks of the CD you played first will be erased.
- All Bookmarks stored in memory will be erased if you remove all power sources, or if you continue playing the player on the rechargeable battery while “Lo Batt” is displayed, without charging the battery.

## Playing your favorite play lists (m3u play list play)

**1** In the step 1 of “Changing Playback Options (PLAY MODE)” (Ⓞ page 19), select 📄 (play list).

**2** Turn the operation dial on the remote toward ◀◀ or ▶▶ to select a play list you want.

**3** Press ▶II.

Continued ⇨

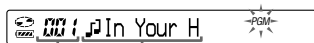

## Playing tracks in your favorite order (PGM play)

- 1 While the player is stopped, turn the function dial on the remote to select P MODE/ and press the function button repeatedly until "PGM" flashes.



Playing order    Track name or file name

- 2 Turn the VOL +/- control to select a track, and then press and hold  until the display changes.

When playing an ATRAC CD/MP3 CD:  
You can also select a track in another group by turning the operation dial toward  or  while you keep the dial pressed in the direction of .



- 3 Repeat step 2 to select tracks in your favorite order.

You can select up to 64 tracks.  
When you finish entering the 64th track, the track number selected first (audio CD)/file name (ATRAC CD/MP3 CD) appears on the display.  
If you select 65 tracks or more, the tracks selected first are erased one by one.

- 4 Press .

Playback starts in the selected order.



### To check the program

- 1 While the player is stopped, turn the function dial to select P MODE/ and press the function button repeatedly until "PGM" flashes. Then, press and hold  on the remote until the display changes.
- 2 Whenever you press and hold  on the remote until the display changes, the tracks are displayed in playing order.

### To cancel the PGM play

Press  on the remote.



## Playing tracks repeatedly (Repeat play)

- 1 Turn the function dial on the remote to select P MODE/ and press the function button repeatedly to select the playback option you want to repeat ( page 20).

- 2 Press and hold the function button until  (repeat) appears.

The playback option you have selected repeats.

### To return to normal play

Turn the function dial on the remote to select P MODE/, and then press and hold the function button until  disappears.

## Changing Sound Quality

For details about the setting of SOUND items, see  page 25.

### Selecting the sound quality

You can set up the “EQUALIZER” setting and/or “CLEARBASS” setting. If you set both at the same time, you can enjoy more bass sound along with the sound quality you want.

- 1 Turn the function dial on the remote to select **SOUND**.
- 2 Press the function button repeatedly until “EQUALIZER” or “CLEARBASS” appears.
- 3 Press **▶II**.
- 4 Turn the operation dial toward **◀◀** or **▶▶** to select the sound quality you want.
- 5 Press **▶II**.

## Customizing sound quality

You can adjust sound quality for each frequency range individually, checking the shape of the wave on the display.

- 1 Turn the function dial on the remote to select **SOUND**, and then press the function button repeatedly until “EQUALIZER” appears and press **▶II**.
- 2 Turn the operation dial toward **◀◀** or **▶▶** repeatedly to select “CUSTOM” and press **▶II**.

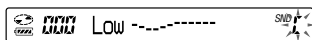

- 3 Turn and hold the operation dial toward **◀◀** or **▶▶** for 2 seconds or more until the frequency range you want to set up appears.

“Low” is displayed first.

There are 3 frequency ranges; “Low” (low range audio), “Mid” (middle range audio), and “Hi” (high range audio).

- 4 Turn the operation dial toward **◀◀** or **▶▶** repeatedly to select the shape of the wave.

There are 3 shapes stored in memory for each frequency range.

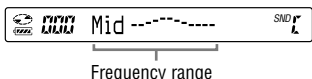

- 5 Turn the **VOL +/-** control repeatedly to select the sound volume.

The sound volume can be adjusted in 7 levels.

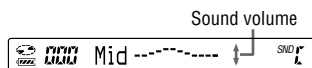

Continued 

---

**6 Repeat steps 3 to 5 to make adjustment for the remaining 2 frequency ranges.**

---

**7 Press ►II.**

**To return to the previous screen**

Press ■ on the remote.

**To cancel the adjustment operation**

Press ■ on the remote for 2 seconds or more.

**Notes**

- If the sound is distorted by your sound settings when you turn up the volume, turn the volume down.
- If you feel a difference in sound volume between the “CUSTOM” sound setting and other sound settings, adjust the volume to your preference.



## SOUND items

To return to the previous screen, press **■**. To cancel the setting operation, press **■** for 2 seconds or more.

Item	Options (●: Default setting)	
EQUALIZER (Equalizer setting)	● OFF	Normal sound quality
	SOFT	For vocal, stressing middle range audio
	ACTIVE	Lively sounds, emphasizing high and low range audio
	HEAVY	Powerful sounds, further emphasizing high and low ranges compared with ACTIVE sound
	CUSTOM	Customized sound (see <a href="#">@</a> page 23 for details)
CLEARBASS (Bass sound setting)	● OFF	Normal sound quality.
	BASS 1	Emphasizing bass sound.
	BASS 2	Emphasizing bass sound more than BASS 1.
	BASS 3	Emphasizing bass sound more than BASS 2.

### Note

If you change the setting of the EQUALIZER items after you have set the CLEARBASS items, the setting of the EQUALIZER items get priority.

When you set both EQUALIZER items and CLEARBASS items, set the EQUALIZER items first.

---

## Changing Optional Settings

For details about the setting of OPTION items, see  page 27.

### Setting various functions

You can set the various functions such as the language for the menu and the playback order of the groups/files.

---

**1** Turn the function dial on the remote to DSPL/MENU, and then press and hold the function button.

---

**2** Turn the operation dial toward **◀◀** or **▶▶** to select the item you want to set up, and then press **▶II**.



---

**3** Turn the operation dial toward **◀◀** or **▶▶** to select an option, and then press **▶II**.

When you are setting the “LANGUAGE” or “PLAYORDER,” repeat step **3**.

## OPTION items

To return to the previous screen, press **■**. To cancel the setting operation, press **■** for 2 seconds or more.

Items	Options (●: Default settings)				
LANGUAGE (Language for menu, etc.)	MENU	● ENGLISH	Select the language for menu text, warning message, etc.		
		FRENCH			
		GERMAN			
		ITALIAN			
		KOREAN*			
		PORTUGUESE			
		RUSSIAN			
		S.CHINESE*			
		SPANISH			
		T.CHINESE*		*D-NE720LS only	
		TEXT <sup>1)</sup>		● AUTO	Select the language for CD-TEXT, ID3 tag, etc. If you select "AUTO" you can read the text in the following language.
				ENGLISH	
				FRENCH	
GERMAN					
ITALIAN					
KOREAN*					
PORTUGUESE					
RUSSIAN					
S.CHINESE*					
SPANISH					
T.CHINESE*	*D-NE720LS only				
G-PROTECTION <sup>1)2)</sup> (To prevent sound skipping)	● 1		Protection against sound skipping is provided with high quality CD sound.		
	2		Enhanced protection against sound skipping is provided.		
AVLS <sup>3)</sup> (Limiting volume)	● OFF	The volume changes without limiting the volume level.			
	ON	The maximum volume is limited to protect your hearing.			

Continued 

Items	Options (●: Default settings)		
TIMER (Off timer)	● OFF	The timer does not work.	
	ON	1-99 min Turn the VOL +/- control on the remote repeatedly to increase or decrease the length of time by 5 minutes, or keep turning the VOL +/- control to increase or decrease by 1 minute. The default setting is "10 min"	
AUDIO OUT <sup>1)</sup> (External audio output)	● HEADPHONE	Select this when you connect the supplied headphones or earphones.	
	LINE OUT	Select this when you connect other devices such as active speakers with an audio cord (☞ page 30).	
BEEP (Sound of operation)	● ON	The beep sounds when you operate the player.	
	OFF	The beep is turned off.	
SEAMLESS <sup>1) 4)</sup> (Playing tracks continuously)	● OFF	The CD is played as recorded on the disc, including spaces between tracks.	
	ON	The CD is played without space between tracks.	
POWERSAVE <sup>1) 5)</sup> (The LCD backlight on the remote and the OPR lamp on the player)	● OFF	On the remote, the display lights up for about 10 seconds, then turns off. The OPR lamp on the player remains lit.	
	1	Neither the display on the remote nor the OPR lamp on the CD player lights up.	
	2	Neither the display on the remote nor the OPR lamp on the CD player lights up. Furthermore, the SOUND settings are not effective.	
PLAYORDER <sup>1)</sup> (Playback order)	TRACK	● NORMAL	Play back the music source in the order of recording.
		ID3tagTNO	Play back in the order of ID3 tag number.
		FILE NAME	Play back in the alphabetical order of the file names.
	GROUP	● OFF	Play back the music source in the order of recording.
		ON	Play back the music source in the order of group names.
DIRECTION (Inverting the characters on the display)	● NORMAL	The characters appear on the remote display in the normal direction.	
	REVERSE	The characters appear on the display in the reverse direction so that you can read them from the opposite side. When you set the CUSTOM items of the EQUALIZER settings, VOL +/- on the remote operate in an opposite way.	

Items	Options (●: Default settings)	
CD-EXTRA <sup>1)6)</sup> (Playback by disc format)	● OFF	Set to "OFF" as long as you can play your CD normally.
	ON	If you cannot play your CD-Extra, set to "ON". You may play it.
ANIMATION (Selecting animation screen)	● OFF	The ordinary playback screen is displayed when you are not playing the player.
	ON	Animation screen appears when you are not playing the player.

- 1) You can set this up only while the player is stopped.
- 2) Depending on the model you purchased, "G-PRO" is displayed on the remote.
- 3) AVLS is an abbreviation of the Automatic Volume Limiter System.
- 4) This function works only for ATRAC CDs.
- 5) Only model D-NE720LS using the remote with LCD backlight.
- 6) This function works only for Audio CDs and CD-Extra CDs.

### Notes

- Even if "G-PROTECTION" is set to "2," sound may skip:
  - when the CD player receives stronger continuous shock than expected,
  - when a dirty or scratched CD is played, or
  - for CD-Rs/CD-RWs, when a poor-quality disc is played or there is a problem with the original recording device or application software.
- Even if "SEAMLESS" is set to "ON," the tracks may not play continuously depending on how the source music was recorded.

## Connecting Other Devices

You can listen to CDs through a stereo system and record CDs on a MiniDisc or a cassette tape. See the instruction manual that comes with the device you want to connect. Be sure to turn off all devices before making the connections and changing the settings explained below.

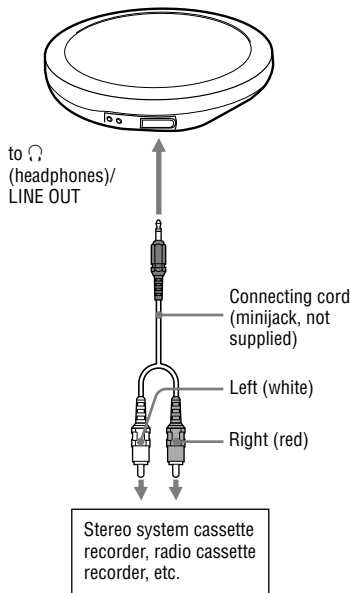

You need to change the setting for “AUDIO OUT” in the OPTION menu so that sound is output to the connected device. The settings of “AUDIO OUT” are shown below. To make those settings, see page 26, 28.

Connected device	Setting
Headphones	HEADPHONE
Device connected using the connected cord	LINE OUT

When you connect another device, set this to “LINE OUT.” When the setting is “LINE OUT,” volume cannot be adjusted using either the player or the remote, and the sound function does not work.

### Notes

- Before you play a CD, turn down the volume of the connected device to avoid damaging the connected speaker.
- Use the AC power adaptor for recording. If you use the rechargeable battery or a dry battery as a power source, the battery may become completely depleted in the middle of recording.
- To record high quality CD sound, set “G-PRO (G-PROTECTION)” to “1” in the OPTION menu.

## Troubleshooting

Should any problem persist after you have checked these symptoms, consult your nearest Sony dealer.

### Power

Symptom	Cause and/or corrective action
The rechargeable battery cannot be charged.	<ul style="list-style-type: none"> <li>→ The rechargeable battery is not inserted in the battery compartment. Insert the rechargeable battery (Ⓞ page 11).</li> <li>→ The CD is playing. Turn it off (Ⓞ page 16)</li> <li>→ While the CD player is stopped, press ■/CHG.</li> <li>→ You press ■ on the remote. Press ■/CHG on the CD player.</li> </ul>

### Sound

Symptom	Cause and/or corrective action
The volume does not increase even if you turn the VOL +/- control on the remote in the + direction repeatedly (even if you press VOL + repeatedly on the player).	<ul style="list-style-type: none"> <li>→ "AVLS" is set to "ON." Set it to "OFF" (Ⓞ page 27).</li> <li>→ "AUDIO OUT" is set to "LINE OUT." Set it to "HEADPHONE" (Ⓞ page 28).</li> </ul>
No sound, or noise is heard.	<ul style="list-style-type: none"> <li>→ Connect the headphones/earphones plugs firmly.</li> <li>→ The plugs are dirty. Clean the headphones/earphones plugs with a dry soft cloth periodically.</li> </ul>
The volume cannot be adjusted.	→ "AUDIO OUT" is set to "LINE OUT." Adjust the volume using the volume control on the connected device, or set "AUDIO OUT" to "HEADPHONE" (Ⓞ page 28).
A rustling noise is heard from the CD.	→ Close the lid of the battery compartment firmly (Ⓞ page 11).
When using the player with a stereo system connected, the sound is distorted or noisy.	<ul style="list-style-type: none"> <li>→ "AUDIO OUT" is set to "LINE OUT." Adjust the volume of the connected device (Ⓞ page 28).</li> <li>→ "AUDIO OUT" is set to "HEADPHONE." Adjust the volume on the player (Ⓞ page 28).</li> </ul>
EQUALIZER items cannot be set up.	→ "POWERSAVE" is set to "2" (Ⓞ page 28).

Continued ➞

## Operation/Playback

Symptom	Cause and/or corrective action
The playing time is too short. The CD does not play.	<ul style="list-style-type: none"><li>→ Check that you are using an alkaline battery and not a manganese battery.</li><li>→ Replace the dry battery with a new LR6 (size AA) alkaline battery (☞ page 12).</li><li>→ Charge and discharge the rechargeable battery several times (☞ page 11).</li></ul>
Certain tracks cannot be played.	<ul style="list-style-type: none"><li>→ You tried to play files saved in a format that is not compatible with this player (☞ page 5).</li><li>→ Change the setting of “CD-EXTRA” in the OPTION menu. You may play your CD (☞ page 29).</li></ul>
“Lo Batt” appears in the display, and the CD does not play.	<ul style="list-style-type: none"><li>→ The rechargeable battery is used up completely. Charge the battery (☞ page 11).</li><li>→ Replace the dry battery with a new LR6 (size AA) alkaline battery (☞ page 12).</li></ul>
“Hi DC in” appears in the display.	<ul style="list-style-type: none"><li>→ An AC power adaptor which is rated higher than the one supplied or recommended is being used. Use only the supplied AC power adaptor or the car battery cord recommended in “Optional Accessories” (☞ page 35).</li></ul>
The CD does not play, or “No Disc” appears on the display when a CD is placed in the player.	<ul style="list-style-type: none"><li>→ The CD is dirty or defective. Clean it or change it.</li><li>→ Check that the CD is inserted with the label side up (☞ page 15).</li><li>→ Moisture condensation has occurred. Leave the CD player aside for several hours until the moisture evaporates.</li><li>→ Close the lid of the battery compartment firmly (☞ page 11).</li><li>→ Make sure the battery is inserted correctly (☞ page 11, 12).</li><li>→ Connect the AC power adaptor to an AC outlet securely (☞ page 14).</li><li>→ Press ►   after one second or more has passed since the AC power adaptor was connected.</li><li>→ The CD-R/CD-RW in the player is blank.</li><li>→ There is a problem with the quality of the CD-R/CD-RW, recording device, or application software.</li></ul>
The OPR lamp flashes on the player when you press a button, and the CD does not play.	<ul style="list-style-type: none"><li>→ The buttons are locked. Slide the HOLD switch back (☞ page 17).</li></ul>
Playback starts from the point you stopped (resume function).	<ul style="list-style-type: none"><li>→ The resume function is working. To start play from the first track, press and hold ►   while the player is stopped until the first track starts playing, or open the lid of the player (☞ page 16 ). Or, remove all power sources, and then insert the battery or connect the AC power adaptor again.</li></ul>
During playback of an ATRAC CD or MP3 CD, the CD does not rotate but you can hear the sound normally.	<ul style="list-style-type: none"><li>→ This player is designed to stop the rotation of an ATRAC CD or MP3 CD during playback to reduce the power consumption. The player is not malfunctioning.</li></ul>



Symptom	Cause and/or corrective action
"No File" appears on the display after you press <b>▶  </b> or when the lid of the player is closed.	<ul style="list-style-type: none"> <li>→ There are no ATRAC3plus/MP3 files on the CD-R/CD-RW.</li> <li>→ A CD-R/CD-RW from which the data has been erased is being used.</li> <li>→ The CD is dirty.</li> </ul>
The LCD display becomes hard to see or slows down.	→ You are using your CD player at high temperatures (above 40°C/104F) or at low temperatures (below 0°C/32F). At room temperature, the display will return to its normal operating condition.
<b>⏮</b> is flashing quickly on the display of the remote control, and you cannot locate the beginning of the track or a specific point in the track.	→ The CD player has entered the preparation stage of Bookmark play. Change the PLAY MODE setting to normal play (no indication) (ⓘ page 20).
Even though you have not selected Bookmark play, <b>⏮</b> (Bookmark) flashes.	→ If you have selected the playback option other than Bookmark play, <b>⏮</b> (Bookmark) flashes.
Play stopped abruptly.	<ul style="list-style-type: none"> <li>→ The off timer has been set. Change the setting of "TIMER" to "OFF" (ⓘ page 28).</li> <li>→ The rechargeable battery or the dry battery is used up completely. Charge the rechargeable battery (ⓘ page 11), or replace the dry battery with a new LR6 (size AA) alkaline battery (ⓘ page 12).</li> </ul>
You cannot operate the player, and a sequence of 8 numbers or letters appear on the display of the remote.	→ This phenomenon may occur, depending on the CD you are using. Remove all power sources, and then insert the battery or reconnect the AC power adaptor. Try to operate the player again. If the problem persists, consult your nearest Sony dealer.

## Others

Symptom	Cause and/or corrective action
When closing the lid of the CD player, the CD starts to rotate.	→ The player is reading the information on the CD, not malfunctioning.
You cannot operate the CD player properly using the remote.	<ul style="list-style-type: none"> <li>→ The buttons on the player are kept pressed by mistake.</li> <li>→ The remote is not connected securely.</li> </ul>

## Maintenance

### To clean the casing

Use a soft cloth slightly moistened in water or a mild detergent solution. Do not use alcohol, benzene or thinner.

## Specifications

### System

Compact disc digital audio system

### Laser diode properties

Material: GaAlAs

Wavelength:  $\lambda = 770 - 800 \text{ nm}$

Emission duration: Continuous

Laser output: Less than  $44.6 \mu\text{W}$

(This output is the value measured at a distance of 200 mm from the objective lens surface on the optical pick-up block with 7 mm aperture.)

### D-A conversion

1-bit quartz time-axis control

### Frequency response

20 - 20 000 Hz  $\pm 1$  dB (measured by JEITA)

### Output (at 3 V input level)

Line output (stereo minijack)

Output level 0.7 V rms at 47 k $\Omega$

Recommended load impedance over 10 k $\Omega$

Headphones (stereo minijack)

Approx. 5 mW + Approx. 5 mW at 16  $\Omega$

(Approx. 1.5 mW + Approx. 1.5 mW at 16  $\Omega$ )\*

\*For the customers in Europe

### Power requirements

- Sony NH-14WM rechargeable battery:  
1.2 V DC  $\times$  1
- LR6 (size AA) battery: 1.5 V DC  $\times$  1
- AC power adaptor (DC IN 3 V jack):  
220 V, 50 Hz (Model for China)  
120 V, 60 Hz (Model for Mexico)
- Rated current: 1 A

### Operating temperature

5°C - 35°C (41°F - 95°F)

### Dimensions (w/h/d) (excluding projecting parts and controls)

Approx. 135.8  $\times$  20.4  $\times$  135.8 mm

(5  $\frac{3}{8}$   $\times$   $\frac{13}{16}$   $\times$  5  $\frac{3}{8}$  in.)

### Mass (excluding accessories)

Approx. 170 g (6.0 oz.)

US and foreign patents licensed from Dolby Laboratories.

Design and specifications are subject to change without notice.

## Optional Accessories







AC power adaptor	AC-E30HG*
Active speaker system	SRS-Z30 SRS-Z510
Car battery cord	DCC-E84
Car connecting pack	CPA-84U
Connecting cord	RK-G129HG RK-G136HG
Earphones (except for the customers in France)	MDR-E931SP MDR-EX71SL MDR-G64SL
Earphones (for the customers in France)	MDR-E808SP

\* Specifications for AC power adaptors vary for each area. Check your local voltage and the shape of the plug before purchasing.

Your dealer may not handle some of the accessories listed above. Please ask the dealer for detailed information about the accessories in your country/region.

# Index

## Symbols

-  (Battery) 11, 13
-  (disc) 15
- 1 (Single play) 20
- a00 (Auto ranking play) 20
- a00 SHUF (Auto ranking shuffle play) 20
-  (Bookmark play) 20, 21
-  (Group play) 20
-  SHUF (Group shuffle play) 20
-  (m3u play list play) 20, 21
- PGM (Program play) 20, 22
-  (Repeat play) 22

## A

- ACTIVE 25
- AC power adaptor 8
- ANIMATION 29
- ATRAC3plus 5
- ATRAC CD 5
- AUDIO OUT 28, 30
- AVLS 27

## B

- Battery carrying case 8
- Battery compartment lid 11
- Battery life 13
- BEEP 28
- BOOKMARK 21

## C

- CD-DA format 5
- CD-EXTRA 29
- CD-Extra 5
- CD-ROM (SonicStage) 8
- CD-TEXT 18
- CLEARBASS 23, 25
- Clip on the remote 8
- CUSTOM 25

## D

- DIRECTION 28

## E

- Earphones 8
- EQUALIZER 23, 25
- External battery case 8, 12

## G

- G-PROTECTION 27
- GROUP 28
- Group 6, 21

## H

- HEADPHONE 28, 30
- HEAVY 25
- HOLD function 17

## I

- ID3 tag 18
- INTRO 20

## L

- LANGUAGE 27
- LINE OUT 28, 30
- List View 17

## M

- m3u play list play 20, 21
- MENU 27
- Mix-Mode CD 5
- MP3 CD 5

## O

- OPTION 27
- Optional Accessories 35

## P

- Pause 16
- Play 16
- PLAYORDER 28
- PLAY MODE 20
- POWERSAVE 28

## R

- Rechargeable battery 8, 11
- Remote control 8
- Remote display 10, 18
- Repeat play 22

**S**

SEAMLESS 28

Search 16, 17

SOFT 25

SonicStage 4

SOUND 25

Stop 16

**T**

TEXT 27

TIMER 28

TRACK 28



